

 MARLEY



POSITIVE VIBRATION  
*RIDDIM*  
QUICK START GUIDE

GUIDE DE DÉMARRAGE RAPIDE

GUÍA DE INICIO RÁPIDO

GUIDA DI RIFERIMENTO RAPIDO

KURZANLEITUNG

SNELSTARTGIDS

PANDUAN MULAI CEPAT

クイックスタート ガイド

快捷使用説明

빠른 시작 가이드



Inside the Box / L'intérieur du carton / Dentro de la caja / In der Verpackung / All'interno dell'imballaggio / In de doos / Di Dalam Kotak / 盒内物品 / セット内容

A.



B.

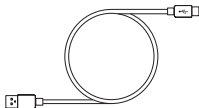

C.

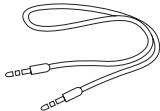

D.

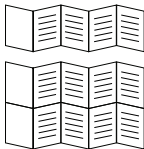

- A. Headphones
- B. Charging Cable USB-C to USB-A
- C. Aux 3.5 Cable
- D. Quick Start Guide and Warranty Information



Components + Charging / Composants + Charge / Componentes + Carga / Komponenten + Aufladen / Component + Carica / Componenten + Opladen / Komponen & Pengisian Daya / 組件 + 正在充電 / 品目 + 充電中

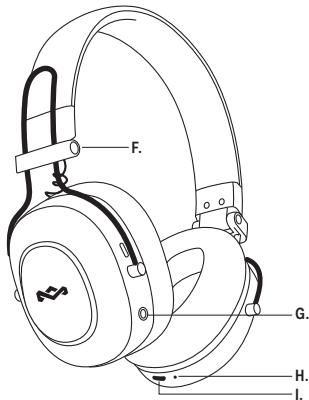
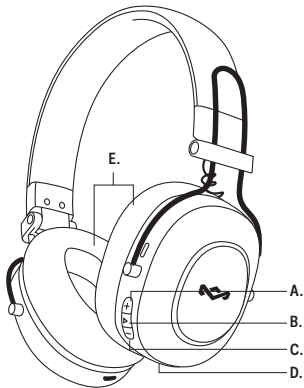

- A. Volume Up/Track Forward
- B. Power On/Power Off +  
Play/Pause + Make/End Phone Calls
- C. Volume Down/Track Backward
- D. Aux-in port
- E. Removable Earcups
- F. Headband Adjustment
- G. Gaming Mode / Movie Mode
- H. LED Indicator
- I. USB-C Charging Port

## Status

- Low Power
- Charging
- Pairing Mode
- Bluetooth® Reconnect
- Bluetooth® Connected
- Phone Call

## LED Indication

- Blinking
- On
- Fast Blinking
- Slow Flash
- Slow Flash
- Fast Blinking



**Power On/Off** / Allumer/Eteindre / Encendido/Apagado / Ein/Aus / Accensione/Spengimento / Aan-/Uitzetten / Daya Nyalakan/Mati / 電源開/閉 / 電源 ON/OFF

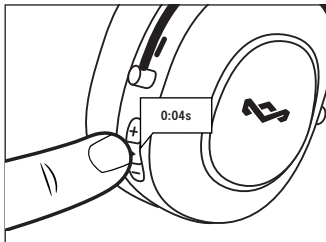

**Pair New Device** / Coupler Nouvel Appareil / Vincular Nuevo Dispositivo / Mit Neum Gerat Koppeln / Accoppia Nuovo Dispositivo / Met Nieuw Apparaat Koppelen / Memasangkan Perangkat Baru / 配对新設備 / 新規デバイスのペアリング

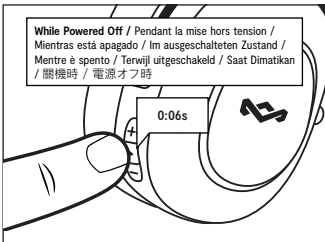

**Pair Device** / Coupler Appareil / Vincular Dispositivo / Mit Gerat Kopplen / Accopia Dispositivo / Met apparaat koppelen / Memasangkan Perangkat / 配對設備 / デバイスのペアリング

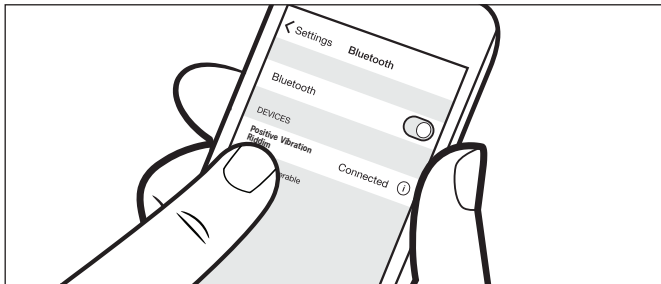

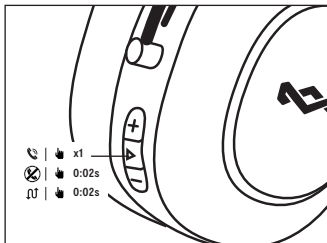
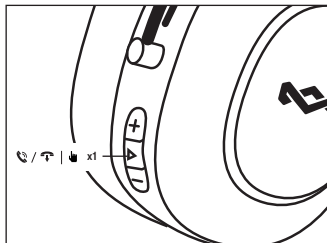
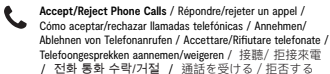
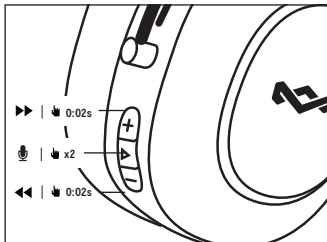
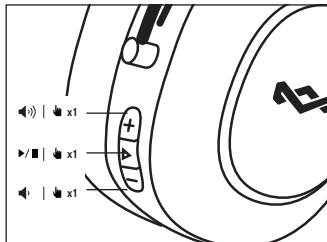

Full instruction and warranty details can be found at  
<https://www.thehouseofmarley.com/customer-support/instruction-books>

Para obtener libro de instrucciones, detalles de garantía y excepciones, visite  
<https://www.thehouseofmarley.com/customer-support/instruction-books>

Pour les informations complètes et les exceptions, rendez-vous sur  
<https://www.thehouseofmarley.com/customer-support/instruction-books>

Weitere Informationen und Ausnahmen erhalten Sie hier  
<https://www.thehouseofmarley.com/customer-support/instruction-books>

Per maggiori informazioni visitare il sito  
<https://www.thehouseofmarley.com/customer-support/instruction-books>

Komplette anvisninger og oplysninger om garanti kan findes på  
<https://www.thehouseofmarley.com/customer-support/instruction-books>

Teljes útmutató és garancianyilatkozat:  
<https://www.thehouseofmarley.com/customer-support/instruction-books>

Pełna instrukcja i warunki gwarancji są dostępne na stronie:  
<https://www.thehouseofmarley.com/customer-support/instruction-books>

Úplné pokyny a detaily záruky nájdete na  
<https://www.thehouseofmarley.com/customer-support/instruction-books>

Правила и условия гарантии полностью изложены по адресу  
<https://www.thehouseofmarley.com/customer-support/instruction-books>

De volledige handleiding en garantiegevens kunnen hier worden gevonden:  
<https://www.thehouseofmarley.com/customer-support/instruction-books>

Fullstendige instruksjoner og garantidetaljer kan finnes på  
<https://www.thehouseofmarley.com/customer-support/instruction-books>

Täydelliset ohjeet ja takuu löytyvät osoitteesta  
<https://www.thehouseofmarley.com/customer-support/instruction-books>

Fullständiga instruktioner och garantiinformation finns på  
<https://www.thehouseofmarley.com/customer-support/instruction-books>

Μπορείτε να βρείτε πλήρεις οδηγίες και λεπτομέρειες για την  
εγγύηση στη διεύθυνση  
<https://www.thehouseofmarley.com/customer-support/instruction-books>

Instruções completas e informações da garantia podem encontrar-se em  
<https://www.thehouseofmarley.com/customer-support/instruction-books>

Talimat ve garanti detaylarının tamamına adresinden erişilebilir  
<https://www.thehouseofmarley.com/customer-support/instruction-books>

如需查看完整说明和质保详情，请访问  
<https://www.thehouseofmarley.com/customer-support/instruction-books>

如需完整說明與保固詳情，請瀏覽  
<https://www.thehouseofmarley.com/customer-support/instruction-books>

取扱説明書の全文および保証内容の詳細は、  
<https://www.thehouseofmarley.com/customer-support/instruction-books>

をご覧ください。  
자세한 설명과 품질보증서 세부사항은  
<https://www.thehouseofmarley.com/customer-support/instruction-books>

에서 확인할 수 있습니다.  
<https://www.thehouseofmarley.com/customer-support/instruction-books>

# POSITIVE VIBRATION

## *RIDDIM*

### QUICK START GUIDE

[HouseofMarley.com](http://HouseofMarley.com)



**BOB MARLEY™**  
**MARLEY™**  
**BOBMARLEY.COM**

©Fifty-Six Hope Road Music Ltd., 2011-2024.  
Right of Publicity and Persona Rights.  
Fifty-Six Hope Road Music Ltd. EM-JHS35B / EM-JHS3CP / EM-JHS3RA

Marley, the Marley logo, Bob Marley and the Bob Marley logo are registered trademarks of Fifty-Six Hope Road Music Limited and any use of such marks by The House of Marley is under license. The Bluetooth® word mark and logos are registered trademarks owned by Bluetooth® SIG, Inc. and any use of such marks by The House of Marley is under license.

 박스 내용물

A.



B.

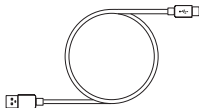

C.

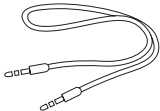

D.

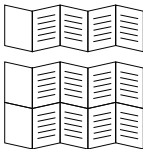

- A. 헤드폰
- B. 충전 케이블 USB-C - USB-A
- C. 보조 케이블
- D. 빠른 시작 가이드 + 보증 정보



# 구성품

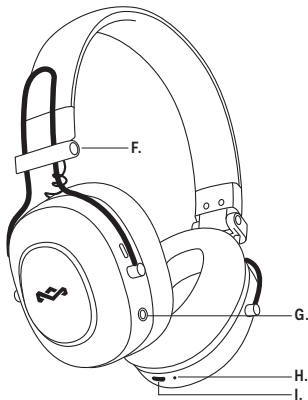
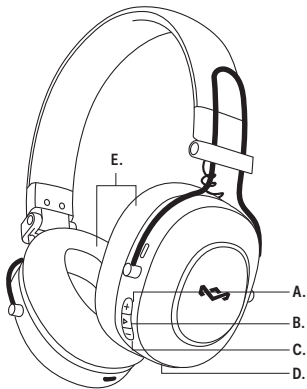

- A. 볼륨 크게/앞으로 이동
- B. 전원 켜짐/전원 꺼짐 + 재생/일시정지 + 전화 걸기/끊기
- C. 볼륨 작게/뒤로 이동
- D. 보조 입력 포트
- E. 분리형 이어컵
- F. 헤드밴드 조정
- G. 게이밍 모드 / 영화 모드
- H. LED 표시등
- I. USB-C 충전 포트

## 상태

- 배터리 부족
- 충전 중
- 페어링 모드
- Bluetooth® 연결되지 않음
- Bluetooth® 연결됨
- 전화 통화

## LED 표시등

- 깜박임
- 켜짐
- 빠르게 깜박임
- 느리게 깜박임
- 느리게 깜박임
- 빠르게 깜박임

## 🔌 전원 켜짐/꺼짐

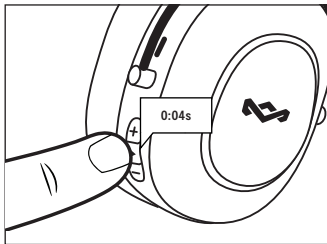

## 📶 새 기기 페어링

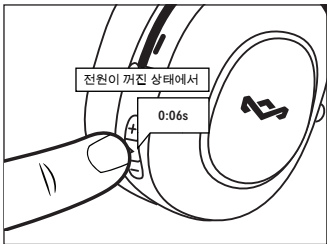

## 📶 기기 페어링

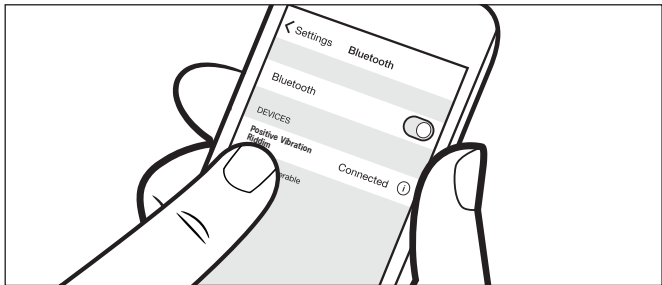

## 🎵 음악 제어

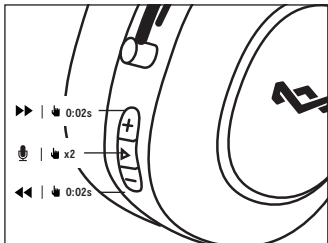
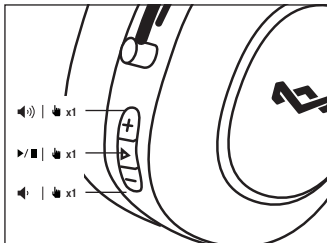

## ☎ 전화 걸기 / 끊기

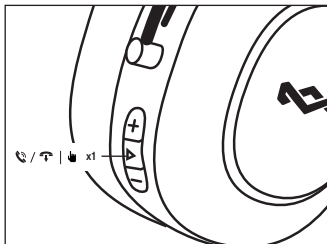

## ☎ 전화 통화 수락/거절

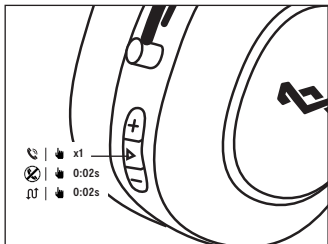



## POSITIVE VIBRATION RIDDIM

### READ ALL INSTRUCTIONS BEFORE USE AND SAVE THESE INSTRUCTIONS FOR FUTURE REFERENCE.

This equipment has been tested and found to comply with the limits for a Class B digital device, pursuant to part 15 of the FCC Rules. These limits are designed to provide reasonable protection against harmful interference in a residential installation. This equipment generates, uses, and can radiate radio frequency energy and, if not installed and used in accordance with the instructions, may cause harmful interference to radio communications. However, there is no guarantee that interference will not occur in a particular installation. If this equipment does cause harmful interference to radio or television reception, which can be determined by turning the equipment off and on, the user is encouraged to try to correct the interference by one or more of the following measures:

- Reorient or relocate the receiving antenna.
- Increase the separation between the equipment and receiver.
- Connect the equipment into an outlet on a circuit different from that to which the receiver is connected.
- Consult the dealer or an experienced radio/TV technician for help.

This device complies with FCC radiation exposure limits set forth for an uncontrolled environment. This device complies with Part 15 of the FCC Rules. Operation is subject to the following two conditions: (1) this device may not cause harmful interference, and (2) this device must accept any interference received, including interference that may cause undesired operation.

### WARNING:

For Australia and New Zealand for charging this equipment, only use Australian approved detachable power supply unit with the output ratings of 5V DC, 500 mA.

### FCC RF EXPOSURE STATEMENT:

This transmitter must not be co-located or operating in conjunction with any other antenna or transmitter. This device complies with FCC radiation exposure limits set forth for an uncontrolled environment.

### CAUTION!

Any changes or modifications not expressly approved by the party responsible for compliance could void the user's authority to operate the equipment.

**ISED STATEMENT:** This device complies with Innovation, Science, and Economic Development Canada license-exempt RSS standard(s). Operation is subject to the following two conditions: (1) this device may not cause interference, and (2) this device must accept any interference, including interference that may cause undesired operation of the device. This Class B digital apparatus complies with Canadian ICES-003.

### ISED RF EXPOSURE STATEMENT:

The device is compliant with RF exposure guidelines, users can obtain Canadian information on RF exposure and compliance.

End user must follow the specific operating instructions for satisfying RF exposure compliance.

The portable device is designed to meet the requirements for exposure to radio waves established by the Federal Communications Commission (USA).

### LE PRÉSENT APPAREIL EST CONFORME

Ce produit est conforme aux limites d'exposition aux RF, les utilisateurs peuvent obtenir les informations concernant l'exposition aux radiofréquences et la conformité.

### BATTERY REPLACEMENT STATEMENT IN EUROPE / AUSTRALIA

Your Positive Vibration Riddim includes a rechargeable battery designed to last the lifetime of the product. In the unlikely event that you should require a replacement battery, please contact Consumer Relations who will supply details of the warranty and out-of-warranty replacement battery service.

## CAUTION

Risk of explosion if the battery is replaced by an incorrect type

- replacement of a battery with an incorrect type that can defeat a safeguard (for example, in the case of some lithium battery types);
- disposal of a battery into fire or a hot oven, or mechanically crushing or cutting of a battery, that can result in an explosion;
- leaving a battery in an extremely high temperature surrounding environment that can result in an explosion or the leakage of flammable liquid or gas;
- a battery subjected to extremely low air pressure that may result in an explosion or the leakage of flammable liquid or gas.

## BATTERY DIRECTIVE

 This symbol indicates that batteries must not be disposed of in the domestic waste as they contain substances which can be damaging to the environment and health. Please dispose of batteries in designated collection points.

## WEEE EXPLANATION

 This marking indicates that this product should not be disposed with other household wastes throughout the EU. To prevent possible harm to the environment or human health from uncontrolled waste disposal, recycle it responsibly to promote the sustainable reuse of material resources.

Hereby, FKA Brands Ltd, declares that this radio equipment is in compliance with the essential requirements and other relevant provisions of Directive 2014/53/EU. A copy of the Declaration of Conformity can be obtained from [www.thehouseofmarley.co.uk/declaration-of-conformity](http://www.thehouseofmarley.co.uk/declaration-of-conformity)

## FR POSITIVE VIBRATION RIDDIM

LIRE TOUTES LES INSTRUCTIONS AVANT UTILISATION. LES CONSERVER POUR POUVOIR LES CONSULTER ULTÉRIEUREMENT.

### DÉCLARATION ISECD

Le présent appareil est conforme aux CNR d'Innovation, Sciences et Développement économique Canada applicables aux appareils radio exempts de licence. L'exploitation est autorisée aux deux conditions suivantes : (1) l'appareil ne doit pas produire de brouillage, et (2) l'utilisateur de l'appareil doit accepter tout brouillage radioélectrique subi, même si le brouillage est susceptible d'en compromettre le fonctionnement.

Cet appareil numérique de classe B est conforme à la norme nmb - 003 du Canada.

### REPLACEMENT DES PILES

Votre enceinte Positive Vibration Riddim comprend une batterie rechargeable conçue pour durer aussi longtemps que le produit. Dans le cas improbable où vous seriez obligé de recourir à une batterie de rechange, veuillez contacter le Service Clientèle qui vous informera sur la garantie de votre produit et le remplacement hors garantie.

### DIRECTIVE RELATIVE AUX PILES ET AUX ACCUMULATEURS

 Ce symbole indique que les piles et les accumulateurs ne doivent pas être jetés avec les déchets ménagers car ils contiennent des substances pouvant être préjudiciables pour la santé humaine et l'environnement. Veuillez utiliser les points de collecte mis à disposition pour vous débarrasser des piles et accumulateurs usagés.

### EXPLICATION WEEE

 Ce symbole indique que le produit ne doit pas être éliminé avec les autres déchets ménagers dans toute l'Union Européenne. L'élimination incontrôlée des déchets pouvant porter préjudice à l'environnement ou à la santé humaine, veuillez le recycler de façon responsable. Vous favoriserez ainsi la réutilisation durable des ressources matérielles.

FKA Brands Ltd déclare par la présente que cet équipement radio est conforme aux exigences essentielles et autres dispositions pertinentes de la Directive 2014/53/EU. Pour obtenir un exemplaire de la Déclaration de conformité, s'adresser à [www.thehouseofmarley.co.uk/declaration-of-conformity](http://www.thehouseofmarley.co.uk/declaration-of-conformity)

## NL POSITIVE VIBRATION RIDDIM

ALLE INSTRUCTIES LEZEN ALVORENS HET PRODUCT IN GEBRUIK TE NEMEN. DEZE INSTRUCTIES ZORGVULDIG BEWAREN.

### BATTERIJEN VERVANGEN

De Positive Vibration Riddim komt met een oplaadbare batterij die is ontworpen om net zolang als het product zelf mee te gaan. In het onwaarschijnlijke geval dat u een nieuwe batterij nodig hebt, kunt u contact opnemen met de klantendienst. De medewerkers van de klantendienst zullen u dan informatie geven over het vervangen van batterijen, al dan niet uit hoofde van garantie.

#### **RICHTLIJN INZAKE BATTERIJEN**

 Dit symbool betekent dat batterijen niet met het huisvuil weggegooid mogen worden, omdat ze stoffen bevatten die schadelijk kunnen zijn voor het milieu en de gezondheid. Lever batterijen op een aangewezen inzamelpunt in.

#### **UITLEGGING OVER AEEA**

 Deze markering geeft aan dat dit product binnen de EU niet met ander huisvuil mag worden weggegooid. Om eventuele schade aan het milieu of de menselijke gezondheid door het ongecontroleerd wegwerpen van afval te voorkomen, dient dit apparaat op verantwoorde wijze gerecycled te worden om duurzaam hergebruik van materiaalbronnen te bevorderen.

Hierbij verklaart FKA Brands Ltd. dat deze radioapparatuur voldoet aan de essentiële eisen en andere relevante voorschriften van Directive 2014/53/EU. Een kopie van de conformiteitsverklaring kan worden verkregen via [www.thehouseofmarley.co.uk/declaration-of-conformity](http://www.thehouseofmarley.co.uk/declaration-of-conformity)

### **IT POSITIVE VIBRATION RIDDIM**

LEGGERE INTEGRALMENTE LE PRESENTI ISTRUZIONI PRIMA DELL'USO. CONSERVARE LE PRESENTI ISTRUZIONI PER CONSULTAZIONI SUCCESSIVE.

#### **SOSTITUZIONE DELLA BATTERIA**

Il tuo sistema Positive Vibration Riddim include una batteria ricaricabile la cui durata corrisponde alla vita utile del prodotto. Nella remota eventualità che ti occorra una batteria di ricambio, contatta il Servizio Clienti che ti fornirà i dettagli del servizio relativo alla batteria sostitutiva in garanzia e non in garanzia.

#### **DIRETTIVA RELATIVA ALLE BATTERIE**

 Questo simbolo indica che le batterie devono essere smaltite separatamente dai rifiuti domestici poiché contengono sostanze potenzialmente nocive per l'ambiente e la salute umana. Smaltire le batterie negli appositi centri di raccolta.

#### **SPIEGAZIONE DIRETTIVA RAEE**

 Questo simbolo indica che il prodotto non deve essere smaltito assieme agli altri rifiuti domestici in tutti i Paesi dell'Unione Europea. Al fine di evitare un eventuale danno ambientale e alla salute umana derivante dallo smaltimento dei rifiuti non controllato, riciclare il prodotto in maniera responsabile per promuovere il riutilizzo sostenibile delle risorse materiali.

Con la presente, FKA Brands Ltd dichiara che l'apparecchiatura radio in oggetto è conforme ai requisiti essenziali e ad altre disposizioni pertinenti della Direttiva 2014/53/EU. È possibile richiedere una copia della Dichiarazione di conformità scrivendo all'indirizzo [www.thehouseofmarley.co.uk/declaration-of-conformity](http://www.thehouseofmarley.co.uk/declaration-of-conformity)

### **SP POSITIVE VIBRATION RIDDIM**

LEA TODAS LAS INSTRUCCIONES ANTES DE USAR. GUARDE ESTAS INSTRUCCIONES PARA REFERENCIA FUTURA.

#### **REEMPLAZO DE BATERÍAS**

Su Positive Vibration Riddim incluye una batería recargable diseñada para funcionar durante la vida útil del producto. En el improbable caso de que necesite un reemplazo de batería, comuníquese con Servicios al Cliente, donde le suministrarán los detalles del servicio de reemplazo de baterías con garantía y sin garantía.

#### **DIRETTIVA RELATIVA A LAS PILAS**

 Este símbolo indica que las pilas no se deben eliminar con la basura doméstica ya que contienen sustancias que pueden ser perjudiciales para el medio ambiente y la salud. Deshágase de las pilas en los puntos de recogida que existen para ese fin.

#### **EXPLICACIÓN RAEE**

 Este símbolo indica que este artículo no se debe tirar a la basura con otros residuos domésticos en ningún lugar de la UE. A fin de prevenir los efectos perjudiciales que la eliminación sin control de los residuos puede tener sobre el medio ambiente o la salud de las personas, le rogamos que los recicle de forma responsable para fomentar la reutilización sostenible de los recursos materiales.

Por la presente, FKA Brands Ltd declara que este dispositivo de radio está en conformidad con los requisitos esenciales y otras disposiciones relevantes de la directiva 2014/53/EU. Si desea una copia de la declaración de conformidad, solicítela a [www.thehouseofmarley.co.uk/declaration-of-conformity](http://www.thehouseofmarley.co.uk/declaration-of-conformity)

## FIN POSITIVE VIBRATION RIDDIM

LUE KAIKKI OHJEET ENNEN KÄYTTÖÄ. SÄILYTÄ NÄMÄ OHJEET TULEVAAN TARVETTA VARTEN. TÄRKEÄT VAROTOIMENPITEET:

### AKUN VAIHTO

Positive Vibration Riddim –kaiuttimessa on ladattava akku, joka on suunniteltu kestämään yhtä pitkään kuin itse kalutien. Jos akku kuitenkin täytyy vaihtaa, ota yhteyttä asiakaspalveluun, mistä saat tiedot takuun piiriin kuuluvan akun ja takuun ulkopuolisen akun korvaavasta toimituspalvelusta.

### AKKUJA KOSKEVA DIREKTIIVI

 Tämä symboli tarkoittaa, että akkuja ei saa hävittää talousjätteiden mukana, koska ne sisältävät aineita, jotka voivat olla vahingollisia ympäristölle ja terveydelle. Vie akut niille tarkoitettuihin keräyspisteisiin.

### WEEE-SELITYS

 Tämä merkki tarkoittaa, että tätä tuotetta ei saa hävittää muiden talousjätteiden mukana missään EU-maassa. Kontrollolmattomasta jätteiden hävittämisestä mahdollisesti aiheutuvien ympäristöhaittojen tai terveysvaarojen estämiseksi hävitä tämä tuote vastuullisesti edistääksesi materiaalivarojen uudelleenkäyttöä.

FKA Brands Ltd. vakuuttaa, että tämä radiolaite on direktiivin 2014/53/EU vaatimusten ja muiden siihen liittyvien säädösten mukainen. Kopion vaatimustenmukaisuusvakuutuksesta voi tilata lähettämällä sähköpostia osoitteeseen [www.thehouseofmarley.co.uk/declaration-of-conformity](http://www.thehouseofmarley.co.uk/declaration-of-conformity)

## DE POSITIVE VIBRATION RIDDIM

LESEN SIE SICH VOR DER BENUTZUNG ALLE HINWEISE GUT DURCH. BEWAHREN SIE DIESE HINWEISE GUT AUF.

### BATTERIEWECHSEL

Ihr Positive Vibration Riddim enthält eine wiederaufladbare Batterie, die für die gesamte Lebensdauer der Lautsprecher halten sollte. In dem unwahrscheinlichen Fall, dass Sie die Batterie ersetzen müssen, wenden Sie sich bitte an unseren Kundendienst, der Sie über die Einzelheiten zum Ersatz der Batterie im Garantiefall und außerhalb der Garantie informieren wird.

### BATTERIE RICHTLINE

 Dieses Symbol weist darauf hin, dass die Batterien nicht mit dem gewöhnlichen Hausmüll entsorgt werden dürfen, da sie Stoffe enthalten, die sich auf Umwelt und Gesundheit schädlich auswirken können. Entsorgen Sie die Batterien bitte an den hierfür vorgesehenen Sammelstellen.

### WEEE-ERKLÄRUNG

 Diese Kennzeichnung weist darauf hin, dass dieses Produkt innerhalb der EU nicht mit anderem Hausmüll entsorgt werden soll. Damit durch unkontrollierte Abfallentsorgung verursachte mögliche Umwelt- oder Gesundheitsschäden verhindert werden können, entsorgen Sie dieses Produkt bitte ordnungsgemäß und fördern Sie damit eine nachhaltige Wiederverwendung der Rohstoffe.

Am Ende der Lebensdauer eines Produkts und vor seiner verantwortungsvollen Entsorgung müssen Sie, sofern vorhanden, alle Lampen und Batterien entfernen. Wenn Ihr Produkt personenbezogene Daten enthält, liegt es in Ihrer Verantwortung, alle personenbezogenen Daten zu entfernen, bevor Sie das Produkt entsorgen. Hinweis: Die Händler von Elektro- und Elektronikgeräten werden Ihr Produkt kostenlos zum Recycling zurücknehmen.

Alternativ können Sie Ihre Elektro- und Elektronikgeräte auch kostenlos bei kommunalen Sammelstellen abgeben.

<https://tinyurl.com/GermanyWEEE>

Hiermit erklärt die FKA Brands Ltd., dass dieses Funkgerät in Übereinstimmung mit den wesentlichen Anforderungen und anderen entsprechenden Bestimmungen der Richtlinie 2014/53/EU geliefert wird. Eine Kopie der Konformitätserklärung ist über

[www.thehouseofmarley.co.uk/declaration-of-conformity](http://www.thehouseofmarley.co.uk/declaration-of-conformity)

## TR POSITIVE VIBRATION RIDDIM

KULLANMADAN ÖNCE TÜM TALİMATLARI OKUYUN. BU TALİMATLARI DAHA SONRA BAŞVURMAK ÜZERE SAK.

### PİL DEĞİŞTİRME

Positive Vibration Riddim'inizda, ürünün ömrü boyunca yetecek şekilde tasarlanmış şarj edilebilir pil bulunmaktadır. Pili değiştirmenizin gerekmesi durumunda, lütfen, size garanti kapsamı ve garanti kapsamı dışında olan pil değiştirme hizmet detaylarını verecek Müşteri Hizmetleriyle temasa geçin.

### PİL DIREKTİFİ

 Bu sembol, çevreye ve sağlığa karşı zararlı olabilen maddeler içerebileceği için pillerin ev atığıyla atılmaması gerektiği gösterir. Lütfen, pilleri belirtilen toplama noktalarına atın.

## WEEE AÇIKLAMASI

 Bu işaret bu ürünün AB genelinde diğer ev atıklarıyla birlikte atılmaması gerektiğini belirtir. Kontrolsüz atığın çevre veya insan sağlığına olası zararları engellemek için sorumlu bir şekilde geri dönüştürülmesini ve malzeme kaynaklarını sürdürülebilir şekilde yeniden kullanılmasını sağlayın.

İş bu vesileyle, FKA Brands Ltd, bu telsiz ekipmanın 2014/53/EU Yönergesinin temel gereksinimleri ve diğer ilgili hükümleriyle uyumlu olduğunu beyan eder. Uygunluk Beyanı'nın bir kopyası [www.thehouseofmarley.co.uk/declaration-of-conformity](http://www.thehouseofmarley.co.uk/declaration-of-conformity)

## SV POSITIVE VIBRATION RIDDIM

LÄS ALLA INSTRUKTIONERNA FÖRE ANVÄNDNING. SPARA DESSA INSTRUKTIONER FÖR FRAMTIDA REFERENS.

### BYTE AV BATTERI

Din Positive Vibration Riddim inkluderar ett återuppladdningsbart batteri som är designat att vara under produktens livslängd. Om du osannolikt skulle behöva byta batterier, kontakta kundtjänst som kommer att ge dig information om garantin och batteribytjänst utanför garantin.

### BATTERIFÖRESKRIFT

 Denna symbol indikerar att batterier inte får avyttras bland hushållssopor eftersom de innehåller substanser som kan skada miljön och hälsan. Avyttra batterier endast vid designerade insamlingspunkter.

### WEEE-FÖRKLARING

 Denna markering indikerar att denna produkt inte får avyttras med annat hushållsavfall inom EU. För att förhindra möjlig skada på miljö eller person från okontrollerat avfallsavyttrande, återvinn på ansvarsfullt vis för att främja det fortsatta återanvändandet av materialresurser.

Härmed deklarerar FKA Brands Ltd att denna radioutrustning är förenlig med nödvändiga krav och andra relevanta bestämmelser i direktivet 2014/53/EU. En kopia av förenlighetsdeklarationen kan erhållas från

[www.thehouseofmarley.co.uk/declaration-of-conformity](http://www.thehouseofmarley.co.uk/declaration-of-conformity)

## RU POSITIVE VIBRATION RIDDIM

ПРОЧИТАЙТЕ ВСЕ ИНСТРУКЦИИ ПЕРЕД ИСПОЛЬЗОВАНИЕМ. СОХРАНИТЕ ЭТИ ИНСТРУКЦИИ ДЛЯ ДАЛЬНЕЙШЕГО ИСПОЛЬЗОВАНИЯ.

### ЗАМЕНА БАТАРЕЙКИ

Динамик Positive Vibration Riddim содержит аккумулятор, срок службы которого соответствует сроку службы продукта. Если возникнет необходимость в замене аккумулятора, обратитесь в службу поддержки. Ее персонал предоставляет гарантийное обслуживание и осуществляет замену аккумуляторов (на замену аккумуляторов действие гарантии не распространяется).

### ИНСТРУКЦИИ К БАТАРЕЯМ

 Данный символ означает, что батареи не следует утилизировать совместно с бытовым мусором, поскольку они содержат вещества, способные нанести вред окружающей среде и здоровью. Утилизируйте батареи в специально предназначенных для этого приемных пунктах.

### ПОЯСНЕНИЕ WEEE

 Данная маркировка означает, что в странах Европы не допускается утилизировать прибор вместе с другими бытовыми отходами. Чтобы не нанести ущерба окружающей среде и здоровью населения в результате неверной утилизации отходов, прибор следует сдать на переработку, чтобы обеспечить экологичное повторное использование материальных ресурсов.

Компания FKA Brands Ltd настоящим подтверждает соответствие данного радиоборудования основным требованиям и другим применимым положениям Директивы 2014/53/EU. Копия Декларации соответствия можно получить по электронному адресу:

[www.thehouseofmarley.co.uk/declaration-of-conformity](http://www.thehouseofmarley.co.uk/declaration-of-conformity)



## DK POSITIVE VIBRATION RIDDIM

LÆS HELE VEJLEDNINGEN IGENNEM FØR BRUG. GEM DENNE VEJLEDNING TIL SENERE BRUG.

### UDSKIFTNING AF BATTERI

Din Positive Vibration Riddim indeholder et genopladeligt batteri, som er beregnet til at vare hele produktets levetid. Hvis det usandsynlige skulle ske, og du har brug for et nyt batteri, bedes du kontakte Kundeservice, som kan informere dig om udskiftning af batteri, både så længe garantien gælder og senere.

### BATTERIDIREKTIV

 Dette symbol indikerer, at batterier ikke må bortskaffes med husholdningsaffald, da de indeholder stoffer, der kan være miljø- og helbredsskadelige. Bortskaf venligst batterier på udpegede indsamlingssteder.

### WEEE FORKLARING

 Denne afmærkning angiver, at dette produkt ikke må bortskaffes med andet husholdningsaffald inden for EU. For at forhindre mulig skade for miljøet eller menneskers sundhed på grund af ukontrolleret affaldsbortskaffelse, skal det genanvendes på ansvarlig vis for at fremme den bæredygtige genanvendelse af materielle ressourcer.

FK&A Brands Ltd erklærer hermed, at dette radioudstyr efterlever de essentielle krav og andre relevante bestemmelser i Direktiv 2014/53/EU. En kopi af Overensstemmelseserklæringen kan fås hos

[www.thehouseofmarley.co.uk/declaration-of-conformity](http://www.thehouseofmarley.co.uk/declaration-of-conformity)

## NO POSITIVE VIBRATION RIDDIM

LES ALLE INSTRUSJONENE FØR BRUK. TA VARE PÅ DISSE INSTRUSJONENE FOR FREMTIDIG REFERANSE.

### SKIFTE BATTERI

Positive Vibration Riddim enheten din har et oppladbart batteri som er konstruert for å vare like lenge som produktet. Skulle det uforutsette skje at du trenger et nytt batteri, ta kontakt med kundetjenesten som vil gi deg informasjon om garantien og utskifting-service for batteri når garantien har utgått.

### BATTERIDIREKTIV

 Dette symbolet indikerer at batteriene ikke må kastes sammen med vanlig husholdningsaffald da de inneholder substanser som kan skade miljøet og helsen. Vær vennlig å kaste batterier i angitte oppsamlingsteder.

### WEEE FORKLARING

 Denne merkingen indikerer at innen EU skal dette produktet ikke kastes sammen med annet husholdningsaffald. For å forebygge mulig skade på miljøet eller menneskelig helse forårsaket av ukontrollert avfallstømming, skal produktet gjenvinnes ansvarlig for å støtte holdbar gjenbruk av materialressurser.

FK&A Brands Ltd, erklærer herved at dette radioudstyret samsvarer med nødvendige krav og andre relevante forskrifter i direktiv 2014/53/EU. En kopi av konformitetserklæringen er tilgjengelig fra

[www.thehouseofmarley.co.uk/declaration-of-conformity](http://www.thehouseofmarley.co.uk/declaration-of-conformity)

## EL POSITIVE VIBRATION RIDDIM

ΔΙΑΒΑΣΤΕ ΟΛΕΣ ΤΙΣ ΟΔΗΓΙΕΣ ΠΡΙΝ ΤΗ ΧΡΗΣΗ. ΦΥΛΑΞΤΕ ΑΥΤΕΣ ΤΙΣ ΟΔΗΓΙΕΣ ΓΙΑ ΜΕΛΛΟΝΤΙΚΗ ΑΝΑΦΟΡΑ.

### ΑΝΤΙΚΑΤΑΣΤΑΣΗ ΜΠΑΤΑΡΙΑΣ

Το ηχείο Positive Vibration Riddim περιλαμβάνει μια αναφορτιζόμενη μπαταρία ειδικά σχεδιασμένη ώστε να διαρκεί για όλη την ωφέλιμη ζωή του προϊόντος. Στην απίθανη περίπτωση που θα χρειαστείτε μπαταρία αντικατάστασης, επικοινωνήστε με την Εξυπηρέτηση Πελατών, η οποία θα σας δώσει λεπτομέρειες για αντικατάσταση της μπαταρίας εντός και εκτός εγγύησης.

### ΟΔΗΓΙΑ ΓΙΑ ΤΙΣ ΜΠΑΤΑΡΙΕΣ

 Το σύμβολο αυτό υποδεικνύει ότι οι μπαταρίες δεν πρέπει να απορρίπτονται μαζί με οικιακά απορρίμματα, καθώς περιέχουν ουσίες που μπορεί να είναι επιβλαβείς για το περιβάλλον και την υγεία. Απορρίψτε τις μπαταρίες στα καθορισμένα σημεία συλλογής.

### ΕΠΕΞΗΓΗΣΗ ΑΗΘΕ

 Αυτή η σήμανση επισημαίνει ότι αυτό το προϊόν δεν πρέπει να απορρίπτεται με άλλα οικιακά απόβλητα σε όλη την ΕΕ. Για να μην προκληθεί ζημιά στο περιβάλλον ή στην υγεία λόγω μη ελεγχόμενης απόρριψης αποβλήτων, ανακυκλώστε το υπεύθυνα, προάγοντας τη βιώσιμη αναχρησιμοποίηση των υλικών πόρων.

Με το παρόν, η FKA Brands Ltd δηλώνει ότι αυτός ο ασύρματος εξοπλισμός συμμορφώνεται με τις ουσιαστικές απαιτήσεις και τις άλλες σχετικές προβλεπές της Οδηγίας 2014/53/ΕΕ. Μπορείτε να αποκτήσετε ένα αντίγραφο της Δήλωσης Συμμόρφωσης αν επικοινωνήσετε με τη διεύθυνση  
[www.thehouseofmarley.co.uk/declaration-of-conformity](http://www.thehouseofmarley.co.uk/declaration-of-conformity)

## CZ POSITIVE VIBRATION RIDDIM

PŘED POUŽITÍM ZAŘÍZENÍ SI PŘEČTĚTE VŠECHNY POKYNY. POKYNY USCHOVEJTE PRO BUDOUCÍ NAHLÉDNUTÍ.

### VÝMĚNA BATERIE

Jednotka Positive Vibration Riddim obsahuje nabíjecí baterii, která by měla být funkční po celou dobu životnosti produktu. Pokud by však bylo třeba baterii vyměnit, kontaktujte zákaznickou službu, která vám poskytne podrobné informace o záruční a mimozáruční výměně baterie.

### POKYNY K BATERII

 Tento symbol znamená, že baterie nesmí být likvidována vyhozením do domácího odpadu, protože obsahuje látky, jež mohou poškodit životní prostředí a zdraví. Za účelem likvidace baterii odevzdejte na určeném sberném místě.

### VYSVĚTLENÍ OEEZ

 Tato značka udává, že výrobek nesmí být na území EU vyhozován s běžným domácím odpadem. Pro prevenci možného znečištění životního prostředí a újmě na zdraví ošetřete nekontrolovaným odpadem recyklujte výrobek odpovědným způsobem.

Společnost FKA Brands Ltd tímto prohlašuje, že toto rádiové vybavení je ve shodě se základními požadavky a dalšími relevantními ustanoveními směrnice 2014/53/EU. Kopii prohlášení o shodě získáte na adrese [www.thehouseofmarley.co.uk/declaration-of-conformity](http://www.thehouseofmarley.co.uk/declaration-of-conformity)

## HU POSITIVE VIBRATION RIDDIM

HASZNÁLAT ELŐTT OLVASSA EL AZ UTASÍTÁSOKAT, ÉS A KÉSŐBBI HASZNÁLATHOZ TEGYE EL EZEKET.

### AZ AKKUMULÁTOR CSERÉJE

A Positive Vibration Riddim újratölthető akkumulátort tartalmaz, amit úgy terveztek, hogy kitartson a termék teljes élettartamáig. Ha mégis szüksége lenne egy csereakkumulátorra, lépjen kapcsolatba az Ügyfélszolgálattal, ahol tájékoztatást adnak a jótállásban foglalt és a jótálláson kívül eső akkumulátorcserével kapcsolatban.

### ELEMEKRE VONATKOZÓ IRÁNYELV

 Ez a szimbólum azt jelzi, hogy az elemek nem dobtathók háztartási hulladék közé, mivel olyan anyagokat tartalmaznak, amelyek károsak lehetnek az környezetre és az egészségre. Kérjük, vigye a használt elemeket a kijelölt gyűjtőhelyre.

### WEEE-MAGYARÁZAT

 Ez a jelölés azt jelzi, hogy ezt a terméket az Európai Unióban nem szabad a háztartási hulladék közé dobni. Az ellenőrzetlen hulladékkezelésből származó környezeti vagy egészségügyi kár elkerülése végett, és a tárgyi készletek fenntartható kezelése jegyében felelősségteljesen hasznosítsa újra.

A FKA Brands Ltd. kijelenti, hogy ez a rádióberendezés eleget tesz a 2014/53/EU irányelv szükséges követelményeinek és egyéb vonatkozó rendelkezéseinek. A megfelelőségi nyilatkozat másolatát a  
[www.thehouseofmarley.co.uk/declaration-of-conformity](http://www.thehouseofmarley.co.uk/declaration-of-conformity)

## PT POSITIVE VIBRATION RIDDIM

LEIA TODAS AS INSTRUÇÕES ANTES DE UTILIZAR. CONSERVE ESTAS INSTRUÇÕES PARA REFERÊNCIA FUTURA.

### SUBSTITUIÇÃO DA BATERIA

O seu Positive Vibration Riddim inclui uma bateria recarregável. Na hipótese pouco provável de necessitar de substituir a bateria, contacte o Serviço de Apoio ao Cliente, que lhe irá disponibilizar informações sobre o serviço de substituição da bateria ao abrigo da garantia e fora da cobertura da garantia.

### INSTRUÇÕES RELATIVAMENTE ÀS PILHAS

 Este símbolo indica que as pilhas não podem ser eliminadas juntamente com o lixo doméstico, dado que contêm substâncias que podem ser prejudiciais para o meio ambiente e a saúde. As pilhas devem ser eliminadas nos pontos de recolha designados.

### EXPLICAÇÃO DA REE

 Esta marcação indica que o produto não deve ser eliminado juntamente com outros resíduos domésticos em toda a UE. Para impedir possíveis danos ambientais ou à saúde humana resultantes de uma eliminação não controlada dos resíduos, este produto deverá ser reciclado de forma responsável de

modo a promover a reutilização sustentável dos recursos materiais.

Desta forma, o FKA Brands Ltd, declara que este equipamento de rádio está em conformidade com os requisitos essenciais outras provisões relevantes da Diretiva 2014/53/EU. É possível obter uma cópia da Declaração de Conformidade através do [www.thehouseofmarley.co.uk/declaration-of-conformity](http://www.thehouseofmarley.co.uk/declaration-of-conformity)

## SK POSITIVE VIBRATION RIDDIM

PRED POUŽITÍM ZARIADENIA SI PREČÍTAJTE VŠETKY POKYNY. POKYNY USCHOVAJTE NA NAHLADNUTIE V BUDÚCNOSTI.

### VÝMENA BATERIE

V reproduktore Positive Vibration Riddim sa nachádza vymeniteľná batéria navrhnutá tak, aby jej životnosť zodpovedala životnosti produktu. Ak sa stane (hoci je to nepravdepodobné), že budete potrebovať náhradnú batériu, obráťte sa na pracovníkov oddelenia služieb zákazníkom, ktorí vám poskytnú podrobné informácie o servise náhradnej batérie vykonávanom v rámci záručnej lehoty a aj po jej skončení.

### POKYNY OHLADNE BATERIE

 Tento znak znamená, že batérie sa nesmú likvidovať spolu s domácim odpadom, pretože obsahujú látky, ktoré môžu znečistiť životné prostredie alebo poškodiť zdravie. Batérie likvidujte v strediskách určených pre zber odpadu.

### WEEE POPIS

 Tento symbol znamená, že výrobok by sa v rámci celej EÚ nemá vyhadzovať do domáceho odpadu. Aby nedošlo k možnému znečisteniu životného prostredia alebo poškodeniu zdravia v dôsledku nekontrolovaného odpadu, je potrebné pristupovať k recyklovaniu zodpovedne a propagovať tak opätovné použitie zdrojových materiálov.

Spoločnosť FKA Brands Ltd. týmto vyhlasuje, že toto rádiové zariadenie je v súlade so základnými požiadavkami a ďalšími relevantnými ustanoveniami Smernice 2014/53/EÚ. Kópiu vyhlásenia o zhode získate na adrese [www.thehouseofmarley.co.uk/declaration-of-conformity](http://www.thehouseofmarley.co.uk/declaration-of-conformity)

## PL POSITIVE VIBRATION RIDDIM

PRZED UŻYCIEM NALEŻY PRZECZYTAĆ CAŁĄ INSTRUKCJĘ. INSTRUKCJĘ NALEŻY ZACHOWAĆ NA PRZYSZŁOŚĆ.

### WYMIANA BATERII

Głośnik Positive Vibration Riddim został wyposażony w baterie wielokrotnego ładowania o żywotności porównywalnej z żywotnością produktu. W przypadku wystąpienia sytuacji wymagającej wymianę baterii należy skontaktować się z działem obsługi klienta, który zapewni informacje dotyczące gwarancji oraz usługi wymiany baterii nieobjętej gwarancją.

### DYREKTYWA DOT. BATERII

 Ten symbol oznacza, że baterii nie można wyrzucać wraz z odpadami domowymi, ponieważ baterie zawierają substancje, które mogą być szkodliwe dla środowiska oraz zdrowia. Baterie należy dostarczyć do wyznaczonych punktów zbiórki.

### OBJAŚNIENIE WEEE

 Ten znak wskazuje, że na obszarze UE przyrządu nie wolno pozbawiać się wyrzucając do śmieci domowych. Aby chronić środowisko i zdrowie, którym zagraża nieodpowiednia utylizacja odpadów, przyrząd należy recyklingować, aby umożliwić odzysk materiałów, z których został wykonany.

Niniejszym firma FKA Brands Ltd oświadcza, że to urządzenie radiowe jest zgodne z podstawowymi wymaganiami oraz innymi właściwymi postanowieniami Dyrektywy 2014/53/EU. Kopię Deklaracji zgodności można uzyskać pod [www.thehouseofmarley.co.uk/declaration-of-conformity](http://www.thehouseofmarley.co.uk/declaration-of-conformity)

## BG POSITIVE VIBRATION RIDDIM

ПРОЧЕТЕТЕ ВСИЧКИ ИНСТРУКЦИИ ПРЕДИ УПОТРЕБА И ГИ ЗАПАЗЕТЕ ЗА БЪДЕЩА СПРАВКА.

ПРЕДУПРЕЖДЕНИЕ: БАТЕРИИТЕ (КУТИЯТА С БАТЕРИИ ИЛИ ПОСТАВЕНИТЕ БАТЕРИИ) НЕ ТРЯБВА ДА СЕ ИЗЛАГАТ НА ПРЕКАЛЕНО ЗАТОПЛЯНЕ КАТО СЛЪНЧЕВА ТОПЛИНА, ОГЪН ИЛИ ДРУГИ ПОДОБНИ. ВНИМАНИЕ: ОПАСНОСТ ОТ ЕКСПЛОЗИЯ АКО БАТЕРИЯТА НЕ Е ПОСТАВЕНА ПРАВИЛНО. ЗАМЕНЕТЕ ЕДИНСТВЕНО СЪС СЪЩИЯ ИЛИ С ПОДОБЕН ВИД.

### ЗАМЯНА НА БАТЕРИЯТА:

Вашият Positive Vibration Riddim включва зареждащи се батерии, предназначени да издържат през целия живот на продукта.

В малко вероятния случай, когато се наложи замяна на батерията, моля свържете се с отдела за клиентско обслужване, който ще Ви осигури информация за гаранцията и услугата за замяна на батерията извън гаранция.

#### ДИРЕКТИВА ЗА БАТЕРИЯТА

 Този символ показва, че батериите не трябва да се изхвърлят с битовите отпадъци, защото съдържат вещества, които може да са опасни за околната среда и за здравето. Моля, изхвърляйте батериите на предназначените за тази цел места.

#### ОЕЕО ОБЯСНЕНИЕ

 Това маркиране показва, че този продукт не трябва да се изхвърля с други битови отпадъци в границите на ЕС. За предотвратяване на евентуална щета за околната среда или за човешкото здраве поради неконтролно изхвърляне на боялука, рециклирайте го отговорно, за да съдействате за екологичната многократна употреба на материалните ресурси.

С настоящето, FKA Brands Ltd, декларира, че това радиосъоръжение е в съответствие на основните изисквания и на други необходими условия на Директива 2014/53/EU. Копие от Декларацията за съответствие може да бъде получено от [www.thehouseofmarley.co.uk/declaration-of-conformity](http://www.thehouseofmarley.co.uk/declaration-of-conformity)

#### RO POSITIVE VIBRATION RIDDIM

CITIȚI TOATE INSTRUCȚIUNILE ÎNAINTE DE UTILIZARE ȘI PĂSTRAȚI-LE PENTRU A LE CONSULTA ÎN VIITOR.

#### ÎNLOCUIREA BATERIILOR

Difuzorul Positive Vibration Riddim include un acumulator conceput să reziste pe toată durata de viață a produsului. În cazul improbable în care ați fi obligat să înlocuiți acumulatorul, contactați Serviciul Clienți care vă va informa cu privire la garanția produsului dumneavoastră și la înlocuirea acumulatorului după expirarea garanției.

#### DIRECTIVA PRIVIND BATERIILE ȘI ACUMULATORII

 Acest simbol indică faptul că nu este permis să se arunce bateriile și acumulatorii cu deșeurile menajere deoarece conțin substanțe care pot dauna mediului și sănătății. Vă recomandăm să predați bateriile și acumulatorii uzate la punctele de colectare puse la dispoziție.

#### EXPLICAȚIA DEEE

 Acest simbol indică faptul că acest produs nu trebuie eliminat împreună cu alte deșeurii menajere pe teritoriul UE. Pentru a preveni posibile prejudicii asupra mediului și sănătății umane din cauza eliminării necontrolate a deșeurilor, reciclați-l cu responsabilitate pentru a favoriza reutilizarea durabilă a resurselor materiale.

FKA Brands Ltd declară că acest dispozitiv radio este în conformitate cu cerințele esențiale și alte prevederi relevante ale Directivei 2014/53/EU. Un exemplar al Declarației de conformitate poate obțineți de la [www.thehouseofmarley.co.uk/declaration-of-conformity](http://www.thehouseofmarley.co.uk/declaration-of-conformity)

#### AR POSITIVE VIBRATION RIDDIM

اقرأ كل الإرشادات وفهمها قبل استخدام المنتج بخلفية واحتفظ بها للرجوع إليها.

استبدل البطارية

يحتوي نظام Positive Vibration Riddim على بطارية قابلة لإعادة الشحن مصممة خصيصًا لاستمراره على مدار عمر المنتج. في حالة احتياجك لبطارية بديلة، وهو أمر بعد الاحتمال، يرجى الاتصال بخدمة العملاء حيث يمكنك الحصول على التفاصيل حول خدمة استبدال البطارية داخل الضمان أو خارجه.

تعليمات البطارية

 يشير هذا الرمز إلى أن البطاريات ينبغي عدم التخلص منها مع سائر المهلفات المنزلية لأنها تحتوي على مواد قد تضر بالبيئة والصحة. يُرجى التخلص من البطاريات في أماكن التجميع المخصصة لمهلفات الأجهزة الكهربائية / الإلكترونية

 يشير هذا الرمز إلى أن المنتج ينبغي عدم التخلص منه مع سائر المهلفات المنزلية الأخرى في جميع أنحاء الاتحاد الأوروبي. لتفادي احتمال وقوع الضرر على البيئة أو الصحة البشرية بسبب التخلص من النفايات بطرق غير خاضعة للضوابط، يُرجى إعادة تدويرها على نحو مسؤول لتعزيز إعادة الاستخدام المستدام العربية

تتوفر FKA Brands Ltd موجهة من هذا الجهاز اللاسلكي يأتي متوافقًا مع المتطلبات اللازمة وغيره من الأحكام ذات الصلة من الأمر الإرشادي 2014/53/EU. ويمكن الحصول على نسخة من إعلان المطابقة على

[www.thehouseofmarley.co.uk/declaration-of-conformity](http://www.thehouseofmarley.co.uk/declaration-of-conformity)

## CN POSITIVE VIBRATION RIDDIM

使用之前請閱讀所有指南並妥善保存以備未來參考

### 更換電池

Positive Vibration Riddim 隨帶一個可充電電池。設備使用期內無需更換電池。當您因某種特殊原因需要更換電池時，請與客服聯繫。客服人員將為您提供詳盡的保修期內和保修期後更換電池的服務說明。

### 廢舊電池的處理

 此符號表示電池不得與家庭廢物一起丟棄，因為電池含有對環境和健康有害的成分。請將廢舊電池送至指定的收集處。

### 歐共體廢棄電子電器設備指南(WEEE)解釋

 此標識表示在歐共體內本產品不得與家庭廢物一起丟棄。無控制的廢物丟棄有害環境或健康，必須避免。請盡力回收廢舊設備，使其持續得以再生利用。

FKA分銷有限公司在此聲明，此無線設備符合2014/53/EU指南的基本要求和其它相關條款。請訪問[www.thehouseofmarley.co.uk/declaration-of-conformity](http://www.thehouseofmarley.co.uk/declaration-of-conformity)以獲取合規聲明的副本。

### NCC WARNING MESSAGE

LP0002低功率射頻器材技術規範\_章節3.8.2

取得審驗證明之低功率射頻器材，非經核准，公司、商號或使用者均不得擅自變更頻率、加大功率或變更原設計之特性及功能。

低功率射頻器材之使用不得影響飛航安全及干擾合法通信；經發現有干擾現象時，應立即停用，並改善至無干擾時方得繼續使用。前述合法通信，指依電信管理法規定作業之無線電通信。

低功率射頻器材須忍受合法通信或工業、科學及醫療用電波輻射性電機設備之干擾。

## ID POSITIVE VIBRATION RIDDIM

BACA SEMUA PETUNJUK SEBELUM PENGGUNAAN DAN SIMPAN PETUNJUK INI UNTUK RUJUKAN DI MASA MENDATANG.

### PENGANTIAN BATERAI

Positive Vibration Riddim Anda mencakup baterai isi ulang yang dirancang untuk bisa dipakai selama masa pakai produk. Apabila Anda memerlukan baterai pengganti, hubungi Layanan Pelanggan yang akan memberikan detail tentang layanan baterai pengganti garansi dan di luar garansi.

### ARAHAN BATERAI

 Simbol ini menunjukkan bahwa baterai tidak boleh dibuang bersama sampah rumah tangga karena mengandung zat yang dapat merusak lingkungan dan kesehatan. Buang baterai di tempat pengumpulan yang telah ditentukan.

### PENJELASAN WEEE

 Tanda ini menunjukkan bahwa produk ini tidak boleh dibuang bersama sampah rumah tangga lain di seluruh UE. Untuk mencegah kemungkinan bahaya pada lingkungan atau kesehatan manusia dari pembuangan limbah yang tidak terkendali, daur ulang produk ini secara bertanggung jawab untuk mempromosikan penggunaan kembali sumber daya bahan secara berkelanjutan.

FKA Brands Ltd dengan ini menyatakan bahwa peralatan radio ini mematuhi persyaratan penting dan ketentuan relevan lainnya dari Arahan 2014/53/EU.

Salinan Pernyataan Kepatuhan bisa diperoleh dari

[www.thehouseofmarley.co.uk/declaration-of-conformity](http://www.thehouseofmarley.co.uk/declaration-of-conformity)

## KR POSITIVE VIBRATION RIDDIM

사용 전에 모든 지침을 읽고 이후 참조할 수 있도록 보관해 두십시오.

### 배터리 교체

Positive Vibration Riddim에는 제품의 수명을 지속하도록 설계된 재충전 배터리가 포함되어 있습니다. 드물지만 배터리를 교체해야 하는 경우에는 고객 서비스 부서에서 문의하여 보증 및 보증 외 배터리 교체 서비스에 대한 상세 정보를 확인하십시오.

## 배터리 지침

 이 기호는 배터리가 환경 및 건강에 해를 끼칠 수 있는 물질을 함유하고 있으므로 가정용 쓰레기로 폐기해서는 안 된다는 것을 나타냅니다. 배터리를 지정된 수거 장소에 버리십시오.

## WEEE 설명

 이 표시는 이 제품을 EU 전역에서 다른 가정용 쓰레기와 함께 폐기해서는 안 된다는 것을 나타냅니다. 통제되지 않은 쓰레기 폐기로 인해 환경이나 인체에 해를 끼치지 않도록 하려면 책임감을 갖고 재활용하여 물질 자원의 지속 가능한 재사용을 촉진하십시오.

FKA BRANDS LTD는 이 무선 장치가 DIRECTIVE 2014/53/EU의 필수 요건 및 기타 관련 조항을 준수함을 선언합니다. 적합성 선언서 (DECLARATION OF CONFORMITY) 사본은 [www.thehouseofmarley.co.uk/declaration-of-conformity](http://www.thehouseofmarley.co.uk/declaration-of-conformity)에서 얻을 수 있습니다.

제12조 DGT의 허가 없이 회사, 기업 또는 사용자는 주파수를 변경하거나 송전을 개선하거나 원래 특성은 물론 성능을 공인된 저전력 무선 주파수 장치로 바꿀 수 없습니다.

제14조 저전력 무선 주파수 장치는 항공기 보안에 영향을 미치거나 합법적 통신을 간섭해서는 안 됩니다. 이를 발견한 경우 사용자는 간섭을 하지 않을 때까지 즉시 작동을 중지해야 합니다. 앞서 말한 합법적 통신이라 함은 무선 통신이 전기통신법에 따라 작동된다는 뜻입니다. 저전력 무선 주파수 장치는 합법적 통신 또는 ISM 전파 방출 장치의 간섭에 민감해야 합니다.



인증받은자의 상호: (주)디엠에이씨인터내셔널

제품명/모델명: 특정소출력 무선기기(무선데이터통신시스템용 무선기기)/EM-JH153 제조자 및 제조국가:

FKA Distributing Co., LLC / China

제조년월:2020-09

인증번호: R-C-DMV-EM-JH153

모델명 (Model): EM-JH153

해당 무선설비는 운용 중 전파혼신 가능성이 있음

해당 무선설비는 전파혼신 가능성이 있으므로 인명안전과 관련된 서비스는 할 수 없음



To prevent possible hearing damage, do not listen at high volume levels for long periods. Full instruction and warranty details can be found at <http://www.thehouseofmarley.com/instructionbooks>.

Con el fin de evitar lesiones auditivas, se aconseja no escuchar a un volumen excesivamente alto durante un periodo prolongado. Para ver los detalles completos y las excepciones, consulte <http://www.thehouseofmarley.com/instructionbooks>

Afin d'éviter tout dommage auditif possible, ne pas écouter à un volume sonore élevé pendant une période prolongée. Pour les informations complètes et les exceptions, rendez-vous sur <http://www.thehouseofmarley.com/instructionbooks>

Um mögliche Hörschäden zu vermeiden, stellen Sie die Lautstärke nicht über einen längeren Zeitraum sehr hoch ein. Weitere Informationen und Ausnahmen erhalten Sie hier <http://www.thehouseofmarley.com/instructionbooks>

Per evitare possibili danni all'udito, non ascoltare audio a livelli elevati di volume per lunghi periodi. Per tutti i dettagli e le eccezioni, visitare il sito <http://www.thehouseofmarley.com/instructionbooks>

Marley and the Marley logo are registered trademarks of Fifty-Six Hope Road Music Limited and the use of such marks by House of Marley is under license. The Bluetooth® word mark and logos are registered trademarks owned by Bluetooth® SIG, Inc. and any use of such marks by The House of Marley is under license.

Operating frequency band: 2402 – 2480MHz  
CE BT Max Power Transmitted Power: -1dBm

Distributed by  
House of Marley, LLC,  
3000 N. Pontiac Trail, Commerce Township, MI 48390.

Distributed in Australia by  
HoMedics Australia Pty Ltd,  
14 Kingsley Close,  
Rowville, Victoria 3178.

Distributed in New Zealand by  
CDB Media Ltd,  
4 Lovell Court,  
Albany, Auckland, New Zealand 0800 232 633

Imported into the UK by  
FKA Brands Ltd, Tonbridge, TN110GP, UK.

Imported into the EU by  
FKA Brands Ltd, 29 Earlsfort Terrace, Dublin 2. IE

QS-EMJH153

EM-JH153

© 2024 House of Marley, LLC.  
All Rights Reserved.







# WARRANTY

---

Garantie / Garanzia / Garantie / Garanzia / Garantie / 保証 / 保修單 / 보증

House of Marley, LLC sells its products with the intent that they are free of defects in manufacture and workmanship for a period of two (2) years from the date of original purchase, except as noted below. House of Marley, LLC warrants that its products will be free of defects in material and workmanship under normal use and service. This warranty extends only to consumers and does not extend to Retailers.

To obtain warranty service on your House of Marley, LLC product, contact a Consumer Relations Representative by telephone at 1-888-251-1076 for assistance. Please be sure to have the model number of the product available.

House of Marley, LLC does not authorize anyone, including, but not limited to, Retailers, the subsequent consumer purchaser of the product from a Retailer or remote purchasers, to obligate House of Marley, LLC in any way beyond the terms set forth herein. This warranty does not cover damage caused by misuse or abuse; accident; the attachment of any unauthorized accessory; alteration to the product; improper installation; unauthorized repairs or modifications; improper use of electrical/power supply; loss of power; dropped product; malfunction or damage of an operating part from failure to provide manufacturer's recommended maintenance; transportation damage; theft; neglect; vandalism; or environmental conditions; loss of use during the period the product is at a repair facility or otherwise awaiting parts or repair; or any other conditions whatsoever that are beyond the control of House of Marley, LLC.

This warranty is effective only if the product is purchased and operated in the country in which the product is purchased. A product that requires modifications or adoption to enable it to operate in any other country than the country for which it was designed, manufactured, approved and/or authorized,

or repair of products damaged by these modifications is not covered under this warranty.

The warranty provided herein shall be the sole and exclusive warranty. There shall be no other warranties express or implied including any implied warranty of merchantability or fitness or any other obligation on the part of the company with respect to products covered by this warranty. House of Marley, LLC shall have no liability for any incidental, consequential, or special damages. In no event shall this warranty require more than the repair or replacement of any part or parts which are found to be defective within the effective period of the warranty. No refunds will be given. If replacement parts for defective materials are not available, House of Marley, LLC reserves the right to make product substitutions in lieu of repair or replacement.

This warranty does not extend to the purchase of opened, used, repaired, repackaged and/or resealed products, including but not limited to sale of such products on internet auction sites and/or sales of such products by surplus or bulk resellers. Any and all warranties or guarantees shall immediately cease and terminate as to any products or parts thereof which are repaired, replaced, altered, or modified, without the prior express and written consent of House of Marley, LLC.

This warranty provides you with specific legal rights. You may have additional rights which may vary from state to state and country to country. Because of individual state and country regulations, some of the above limitations and exclusions may not apply to you. In India: Warranty is only for products imported and marketed by Imagine Marketing Pvt. Ltd.

Contact: Imagine Marketing Pvt. Ltd. Consumer Relations at 022-42102401.

House of Marley, garantiza que este producto está libre de defectos de material y mano de obra durante un periodo de 2 años a partir de la fecha de compra. Esta garantía no cubre los daños causados por el mal uso o abuso, accidentes, acoplamiento de accesorios no autorizados, cualquier alteración al producto, u otras condiciones ajenas al control de House of Marley,. Aquí <http://www.thehouseofmarley.com/instructionbooks> podrá consultar la hoja de instrucciones íntegra y los detalles de la garantía.

House of Marley, garantit ce produit contre tout défaut de matière et de fabrication pendant 2 ans à compter de la date d'achat. Cette garantie ne couvre pas tout dommage occasionné par un usage incorrect ou abusif, un accident, le raccordement de tout accessoire non autorisé, la modification du produit ou par toute autre situation, de quelque nature qu'elle soit, indépendante de House of Marley,. Vous trouverez les instructions complètes et les informations relatives à la garantie à l'adresse <http://www.thehouseofmarley.com/instructionbooks>

FKA Brands Ltd verkauft seine House of Marley, Produkte mit dem Ziel, dass diese frei von Mängeln und technischen Defekten sind. FKA Brands Ltd gewährt auf seine House of Marley,- Produkte eine 2-jährige Herstellergarantie auf neue Produkte ab dem Kaufdatum. Diese Garantie gilt nicht für Schäden durch unsachgemäßen Gebrauch oder Missbrauch sowie bei Anbringung von unzulässigem Zubehör sowie bei selbst vorgenommenen Änderungen am Produkt. Ein Garantieanspruch ist für gebraucht gekaufte Produkte ausgeschlossen. Die Garantie gilt für Produkte, die für den bestimmungsgemäßen Gebrauch innerhalb der EU und Großbritannien hergestellt worden sind. FKA Brands Ltd und seine angeschlossenen Gesellschaften haften nicht für Neben-, Folgeschäden. Im Garantiefall wenden Sie sich bitte unter Vorlage des Kaufbeleges an FKA Brands Ltd, Somerhill Business Park, Five Oak Green Road, Tonbridge, Kent TN11 0GP oder kontaktieren unseren Kundenservice per Email [cs@thehouseofmarley.de](mailto:cs@thehouseofmarley.de) bzw. Telefonisch unter 069 – 380 789 675. Unabhängig von dieser Garantie haben Sie selbstverständlich die vollen gesetzlichen

Gewährleistungsrechte gegenüber dem Verkäufer. Im Gewährleistungsfall wenden Sie sich bitte mit dem entsprechenden Kaufbeleg an den Verkäufer. House of Marley, garantisce il presente prodotto contro difetti di materiale e lavorazione per un periodo di 2 anni dalla data di acquisto. La presente garanzia non copre eventuali danni causati dall'utilizzo improprio del prodotto, da eventi accidentali, dall'uso di accessori non omologati, da alterazioni apportate al prodotto o da altre condizioni al di fuori del controllo di House of Marley,. Le istruzioni complete e i dettagli sulla garanzia sono disponibili alla pagina <http://www.thehouseofmarley.com/instructionbooks>

-Komplette anvisninger og oplysninger om garanti kan findes på: <http://www.thehouseofmarley.com/instructionbooks>

-Teljes útmutató és garancianyilatkozat: <http://www.thehouseofmarley.com/instructionbooks>

-Pela instrukcja i warunki gwarancji są dostępne na stronie: <http://www.thehouseofmarley.com/instructionbooks>

-Úplné pokyny a detaily záruky nájdete na: <http://www.thehouseofmarley.com/instructionbooks>

-Правила и условия гарантии полностью изложены по адресу: <http://www.thehouseofmarley.com/instructionbooks>

-De volledige handleiding en garantiegegevens kunnen hier worden gevonden: <http://www.thehouseofmarley.com/instructionbooks>

-Fullstendige instruksjoner og garantidetaljer kan finnes på: <http://www.thehouseofmarley.com/instructionbooks>

-Täydelliset ohjeet ja takuu löytyvät osoitteesta: <http://www.thehouseofmarley.com/instructionbooks>

-Fullständiga instruktioner och garantiinformation finns på: <http://www.thehouseofmarley.com/instructionbooks>

-Μπορείτε να βρείτε πλήρεις οδηγίες και λεπτομέρειες για την εγγύηση στη διεύθυνση: <http://www.thehouseofmarley.com/instructionbooks>

-Instruções completas e informações da garantia podem encontrar-se em: <http://www.thehouseofmarley.com/instructionbooks>

-Talimat ve garanti detaylarının tamamina: <http://www.thehouseofmarley.com/instructionbooks> adresinden erişilebilir

## WARRANTY – AUSTRALIA (TWO YEAR WARRANTY)

**We** or **us** means HoMedics Australia Pty Ltd ACN 31 103 985 717 and our contact details are set out at the end of this warranty; **You** means the purchaser or the original end-user of the Goods. You may be a domestic user or a professional user; **Supplier** means the authorized distributor or retailer of the Goods that sold you the Goods in Australia and New Zealand; and **Goods** means the product or equipment which was accompanied by this warranty and purchased in Australia and New Zealand.

Our Goods come with guarantees that cannot be excluded under the Australian Consumer Law. You are entitled, subject to the provisions of the Australian Consumer Law, to a replacement or refund for a major failure and for compensation for any other reasonably foreseeable loss or damage. You are also entitled, subject to the provisions of the Australian Consumer Law, to have the Goods repaired or replaced if the goods fail to be of acceptable quality and the failure does not amount to a major failure. This is not a complete statement of your legal rights as a consumer.

### FOR NEW ZEALAND:

Our Goods come with guarantees that cannot be excluded under the Consumer Guarantees Act 1993. This guarantee applies in addition to the conditions and guarantees implied by that legislation.

### THE WARRANTY:

HoMedics Australia Pty Ltd sells its products with the intent that they are free of defects in manufacture and workmanship under normal use and service. In the unlikely event that your HoMedics Australia Pty Ltd product proves to be faulty within 2 year from the date of purchase due to workmanship or materials only, we will replace it at our own expense, subject to the terms and conditions of this guarantee. The warranty period is limited to 3 months from the date of purchase for products used commercially/professionally.

### TERMS AND CONDITIONS:

In addition to the rights and remedies that you have

under the Australian Consumer Law, Consumer Guarantees Act of New Zealand or any other applicable law and without excluding such rights and remedies warranty against defects:

1. The Goods are designed to withstand the rigors of normal household use and are manufactured to the highest standards using the highest quality components. Whilst unlikely, if, during the first 24 months (3 months commercial use) from their date of purchase from the Supplier (Warranty Period), the Goods prove defective by reason of improper workmanship or materials and none of your statutory rights or remedies apply, we will replace the Goods, subject to the terms and conditions of this warranty.

2. We do not have to replace the Goods under this Additional Warranty if the Goods have been damaged due to misuse or abuse, accident, the attachment of an operating part from failure to provide manufacturer's recommended maintenance, transportation damage, theft, neglect, vandalism, environmental conditions or any other conditions whatsoever that are beyond the control of HoMedics Australia Pty Ltd.

3. This Warranty does not extend to the purchase of used, repaired or second-hand products or to products not imported or supplied by HoMedics Australia Pty Ltd, including but not limited to those sold on offshore internet auction sites.

4. This Warranty extends only to consumers and does not extend to suppliers.

5. Even when we do not have to replace the goods, we may decide to do so anyway. In some cases, we may decide to substitute the goods with a similar alternative product of our choosing. All such decisions are at our absolute discretion.

6. All such replaced or substituted goods continue to receive the benefit of this Additional Warranty for the time remaining on the original warranty period (or 3 months, whichever is the longest).

7. This Additional Warranty does not cover items damaged by normal wear and tear including but not limited to chips, scratches, abrasions, colouration and other minor defects, where the damage has negligible effect on the operation or performance of the goods.

8. This Additional Warranty is limited to replacement or substitution only. As far as the law permits, we will not be liable for any loss or damage caused to property or persons arising from any cause whatsoever and shall have no liability for any incidental, consequential, or special damages.

9. This warranty is only valid and enforceable in Australia and New Zealand.

#### **MAKING A CLAIM:**

In order to claim under this Warranty, you must return the goods to the supplier (place of purchase) for replacement. If this is not possible, please contact Consumers Relations by email at [thehouseofmarley@homedics.com.au](mailto:thehouseofmarley@homedics.com.au) or at the address below.

All returned goods must be accompanied by satisfactory proof of purchase which clearly indicates the name and address of the supplier, the date and place of purchase and identification of the product. It is best to provide an original, legible and unmodified receipt or sales invoice. You must bear any expense for return of the goods or otherwise associated with making your claim under this Additional Warranty.

Distributed in Australia by  
HoMedics Australia Pty Ltd,  
14 Kingsley Close, Rowville  
Victoria 3178.

Distributed in New Zealand by  
CDB Media Ltd,  
4 Lovell Court,  
Albany, Auckland, New Zealand 0800 232 633

# **HOUSE OF MARLEY, LLC HEADQUARTERS**

3000 N Pontiac Trail

Attn: Dept. 168

Commerce Township, MI 48390

248-863-3000

## **CONSUMER SUPPORT**

1-888-251-1076

8:30am to 7:00pm, Eastern

Monday through Friday

# POSITIVE VIBRATION

## *RIDDIM*

### QUICK START GUIDE

[HouseofMarley.com](http://HouseofMarley.com)



**BOB MARLEY™**  
**MARLEY™**  
**BOBMARLEY.COM**

©Fifty-Six Hope Road Music Ltd., 2011-2024.  
Right of Publicity and Persona Rights.  
Fifty-Six Hope Road Music Ltd. EM-JH535B / EM-JH53CF / EM-JH53RA

Marley, the Marley logo, Bob Marley and the Bob Marley logo are registered trademarks of Fifty-Six Hope Road Music Limited and any use of such marks by The House of Marley is under license. The Bluetooth® word mark and logos are registered trademarks owned by Bluetooth® SIG, Inc. and any use of such marks by The House of Marley is under license.